











PIECES DE RECHANGE SPARE PARTS

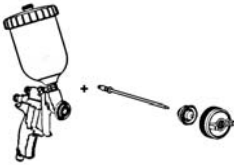
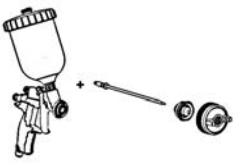



M22 G

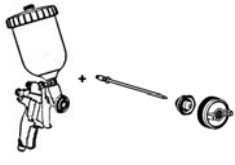

HTi – HPA – GSP (HPA)

M 22 G HTi (K HVLP)			M 22 G HTi		
					
		#			#
	-	136.130.100		-	136.130.100
	+ 12 E5 KHVLP	136.130.101		+ 12 EP 5	136.130.111
	+ 13 E5 KHVLP	136.130.102		+ 13 EP 5	136.130.112
	+ 14 E5 KHVLP	136.130.103		+ 14 EP 5	136.130.113
	+ 15 E5 KHVLP	136.130.104		+ 15 EP 5	136.130.114
	+ 18 E5 KHVLP	136.130.105		+ 18 EP 5	136.130.115
	+ 22 E5 KHVLP	136.130.106		+ 22 EP 5	136.130.116

M 22 G HPA		
		
		#
	-	136.135.100
	+ 12 EN 5	136.135.101
	+ 13 EN 5	136.135.102
	+ 14 EN 5	136.135.103
	+ 15 EN 5	136.135.104
	+ 18 EN 5	136.135.105
	+ 22 EN 5	136.135.106

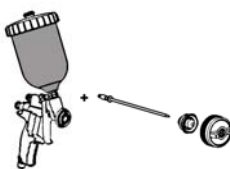
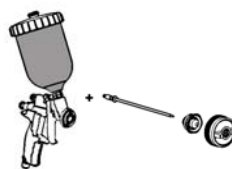

M 22 G HTi (K HVL P)			M 22 G HTi		
					
		#			#
	-	136.131.100		-	136.131.100
	+ 12 E5 KHVLP	136.132.107 (0,25 l)		-	-
	+ 12 E5 KHVLP	136.131.101		+ 12 EP 5	136.131.111
	+ 13 E5 KHVLP	136.131.102		+ 13 EP 5	136.131.112
	+ 14 E5 KHVLP	136.131.103		+ 14 EP 5	136.131.113
	+ 15 E5 KHVLP	136.131.104		+ 15 EP 5	136.131.114
	+ 18 E5 KHVLP	136.131.105		+ 18 EP 5	136.131.115
	+ 22 E5 KHVLP	136.131.106		+ 22 EP 5	136.131.116

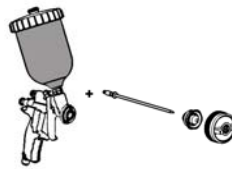
M 22 G HPA		
		
		#
	-	136.136.100
	+ 12 EN 5	136.136.101
	+ 13 EN 5	136.136.102
	+ 14 EN 5	136.136.103
	+ 15 EN 5	136.136.104
	+ 18 EN 5	136.136.105
	+ 22 EN 5	136.136.106

M 22 GSP		
		#
	-	136.138.100
	+ 15 EN 5	136.138.104
	+ 18 EN 5	136.138.105
	+ 22 EN 5	136.138.106

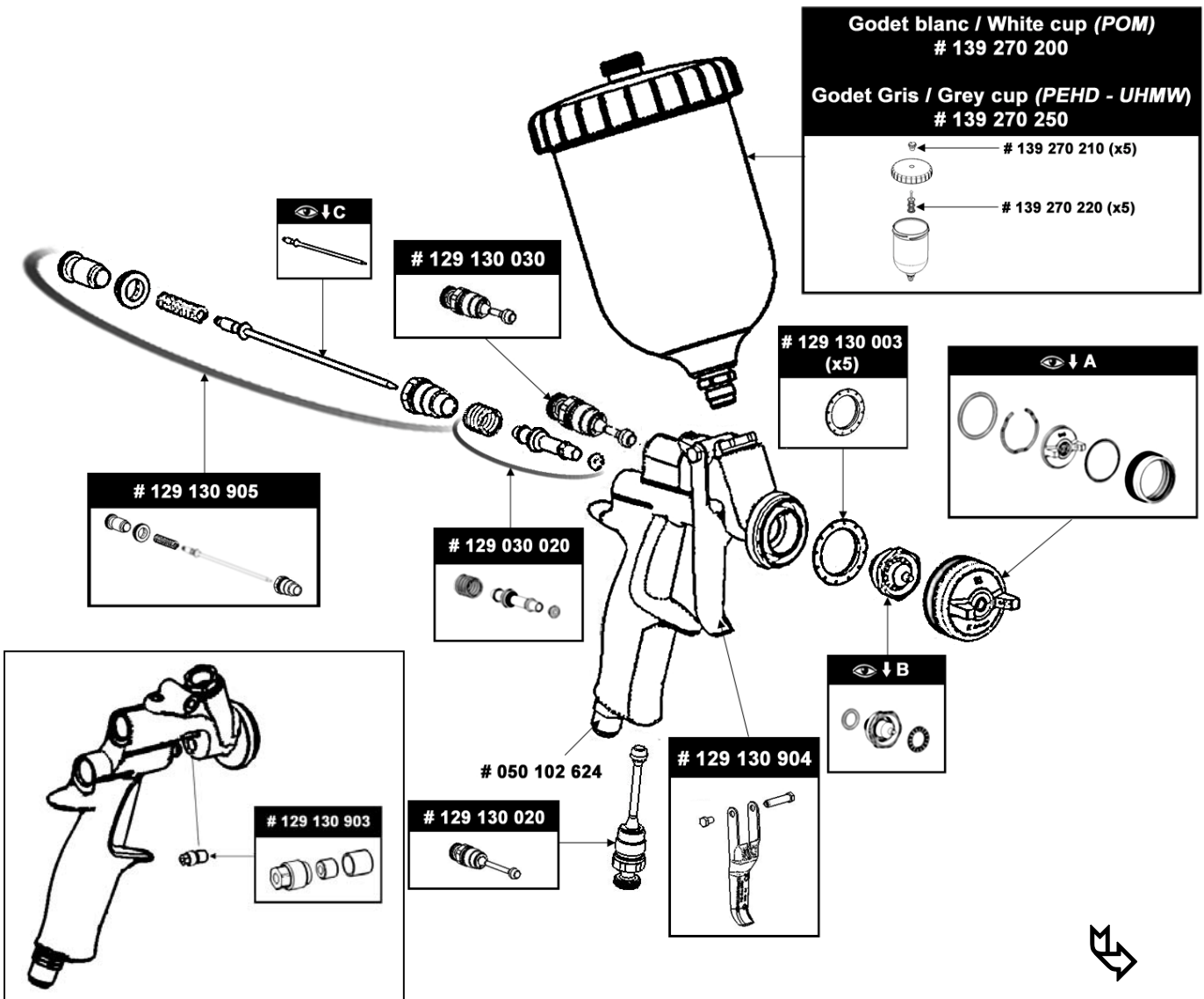

M 22 GSP (HPA)

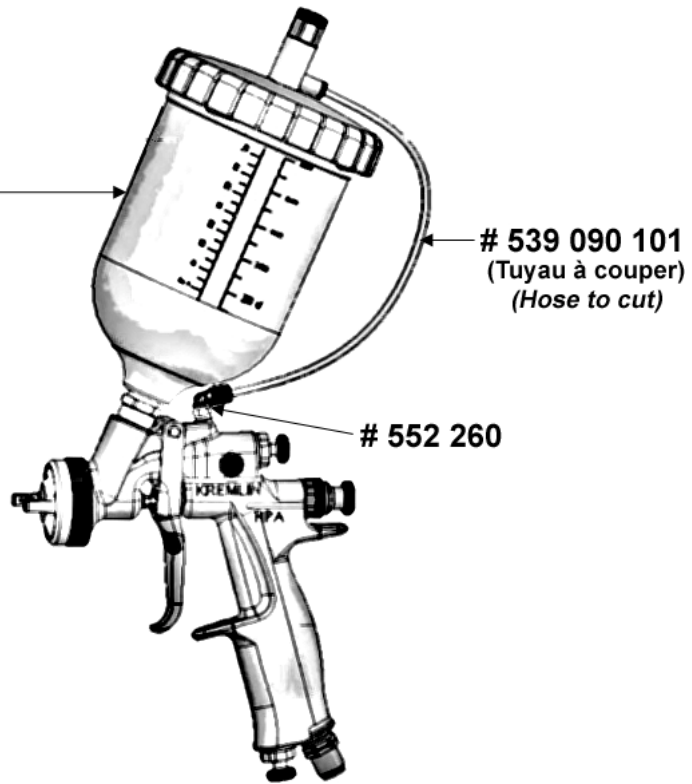
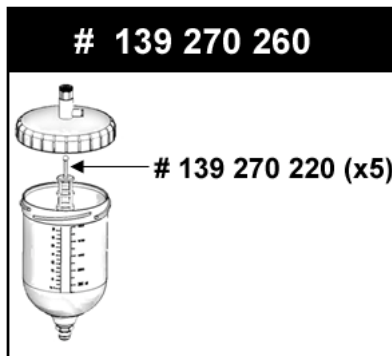

		A		B		C	
	#		#		#		#

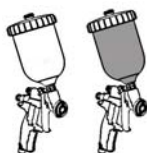

9 E 5 K HVLP	031.130.007	E 5 K HVLP	132.130.100	9	134.130.200	07 - 09 - 12 - 13	033.130.100
12 E 5 K HVLP	031.130.001			12	134.130.300		
13 E 5 K HVLP	031.130.002			13	134.130.400		
14 E 5 K HVLP	031.130.003			14	134.130.500	14 - 15 - 18	033.130.200
15 E 5 K HVLP	031.130.004			15	134.130.600		
18 E 5 K HVLP	031.130.005			18	134.130.700		
22 E 5 K HVLP	031.130.006			22	134.130.800	22 - 27	033.130.300

12 EP 5	031.130.011	EP 5	132.130.300	12	134.130.300	07 - 09 - 12 - 13	033.130.100
13 EP 5	031.130.012			13	134.130.400		
14 EP 5	031.130.013			14	134.130.500	14 - 15 - 18	033.130.200
15 EP 5	031.130.014			15	134.130.600		
18 EP 5	031.130.015			18	134.130.700		
22 EP 5	031.130.016			22	134.130.800	22 - 27	033.130.300

12 EN 5	031.135.001	EN 5	132.130.200	12	134.130.300	07 - 09 - 12 - 13	033.130.100
13 EN 5	031.135.002			13	134.130.400		
14 EN 5	031.135.003			14	134.130.500	14 - 15 - 18	033.130.200
15 EN 5	031.135.004			15	134.130.600		
18 EN 5	031.135.005			18	134.130.700		
22 EN 5	031.135.006			22	134.130.800	22 - 27	033.130.300



15 EN 5	031.135.004	EN 5	132.130.200	15	134.130.600	14 - 15 - 18	033.130.200
18 EN 5	031.135.005			18	134.130.700		
22 EN 5	031.135.006			22	134.130.800	22 - 27	033.130.300



049 030 042



906 300 101



Mamomètre à la crose
Handle gauge
150 070 560



139 280 250 (0,25l)



139 270 210 (x5)

139 270 220 (x5)

Tête de contrôle E 5 KHVLP
E 5 KHVLP test air cap
668 668 597

UNITED STATES
ONLY



049 221 900



049 221 800

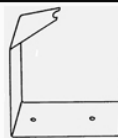

M22 G HTi - M22 G HPA

Pointeau avec embout en résine acétal
Needle with polyacetal needle-end



033 130 400 (07P - 09P - 12P - 13P)

033 130 500 (14P - 15P - 18P)

033 130 300 (22 -27)

129 140 092 (x5) (07P - 09P - 12P - 13P)

129 140 093 (x5) (14P - 15P - 18P)

129 140 090 (x5) (22 -27)